

Read This First

Operating Instructions

1 Setting up your
CLIÉ™ handheld

2 Basic operations of
your CLIÉ™ handheld

3 Using CLIÉ Manuals
with your computer

Troubleshooting

CLIÉ™ handheld
components

Personal Entertainment Organizer
PEG-TJ35
PEG-TJ25

CLIÉ™

© 2003 Sony Corporation



MEMORY STICK

The following manuals are included with your CLIÉ handheld.
Refer to the following together with this manual.

Printed manual

Read This First (Operating Instructions), this manual

Explains how to set up your CLIÉ handheld and computer, and basic operations.
For safe use, make sure to read the supplied “Safety & Regulations Guide”.

Manuals to be read on your computer

The following manuals are automatically installed on your computer after you set up your CLIÉ handheld and computer.

➔ For details on each manual, refer to “Using CLIÉ Manuals with your computer” on page 35.

Applications Guide (PDF format*)

Introduces the supplied applications and briefly explains how to use them.

Handbook (PDF format*)

Explains the basic operations and advanced features of your CLIÉ handheld.

CLIÉ Application Manual (HTML format)**

Explains how to use the supplied applications in detail.

Troubleshooting Q&A (PDF format*)

Helps in solving common problems that you may have while using your CLIÉ handheld.

* You can read the manual on your computer using **Adobe Acrobat Reader**. If **Adobe Acrobat Reader** is not installed on your computer, install it from the supplied Installation CD-ROM.

** You can read the manual on your computer using an Internet browser.

Before use

Caution

IN NO EVENT SHALL SONY BE LIABLE FOR ANY INCIDENTAL, INDIRECT OR CONSEQUENTIAL DAMAGES OR OTHER DAMAGES INCLUDING WITHOUT LIMITATION LOSS OF PROFITS, LOSS OF REVENUE, LOSS OF DATA, LOSS OF USE OF THE PRODUCT OR ANY ASSOCIATED EQUIPMENT, DOWNTIME, AND PURCHASER'S TIME RELATED TO OR ARISING OUT OF THE USE OF THIS PRODUCT, ITS HARDWARE AND/OR ITS SOFTWARE.

On the supplied software

- Copyright laws prohibit reproducing the software or the software manual in whole or in part or renting the software without the permission of the copyright holder.
- In no event will SONY be liable for any financial damage or loss of profits, including claims made by third parties, arising out of the use of the software supplied with this product.
- In the event a problem occurs with this software as a result of defective manufacturing, SONY will replace it at SONY's option or issue a refund. However, SONY bears no other responsibility.
- The software provided with this product cannot be used with equipment other than that which it is designated for use with.
- Please note that, due to continued efforts to improve quality, the software specifications may be changed without notice.
- The software library incorporated in the CLIE handheld is based in part on the work of the Independent JPEG Group.

NOTES

- Sony does not support third party add-on applications. If you have a problem with a third party application, please contact the developer or publisher of that software.
- The illustrations in this manual may differ from the actual software.
- Explanations in this manual assume that you are familiar with basic operations of Windows®. For how to use your computer and operating system, please refer to their respective manuals.

Program © 2003 Sony Corporation, © 2003 PalmSource, Inc., or its subsidiaries. All rights reserved.

Documentation © 2003 Sony Corporation

Table of Contents

Setting up your CLIÉ™ handheld

Confirming the package contents	6
---	---

Setting up your CLIÉ™ handheld	8
--	---

Step 1: Charging your CLIÉ handheld	8
Step 2: Performing the initial setup after turning on your CLIÉ handheld for the first time	9

Using your CLIÉ™ handheld with your computer	15
--	----

Step 1: Installing the software on your computer	15
Step 2: Registering your CLIÉ handheld	17
Step 3: Connecting your CLIÉ handheld and computer via the USB cable	18
Step 4: Entering a user name for your CLIÉ handheld	19



Installing the supplied applications on your CLIÉ™ handheld	20
---	----

Basic operations of your CLIÉ™ handheld

Turning on/off your CLIÉ™ handheld	21
--	----

Turning on your CLIÉ handheld	21
---	----

Starting an application	22
-----------------------------------	----

Using the Jog Dial™ navigator and  /  (the Left/Right buttons)	22
--	----

Other ways to start an application	24
--	----

Entering text	26
-------------------------	----

Using Graffiti® 2 writing to enter text	26
---	----

Other ways to enter text	28
------------------------------------	----

Synchronizing data between your CLIÉ handheld and computer (the HotSync® operation)	29
---	----

Restarting your CLIÉ™ handheld	32
--	----

Using CLIÉ Manuals with your computer

Manuals Overview	35
Opening CLIÉ Manuals	37
Reading the PDF manuals on your computer	38
Reading the HTML manual on your computer (CLIÉ Application Manual)	39

Troubleshooting

Making a backup of the data or applications on your CLIÉ handheld	41
Frequently Asked Questions	42
Customer Support and Customer Registration	52
Notes on use	53
Specifications	57

CLIÉ™ handheld components

Front panel	59
Back panel	61
Locating the components of the CLIÉ Launcher	65

INDEX	70
-----------------	----

Notes on this manual

- This manual supports PEG-TJ35 and PEG-TJ25.
 - The illustrations in this manual are for PEG-TJ35, unless specified otherwise.
 - Differences between PEG-TJ35 and PEG-TJ25 are specified in each corresponding section.
- Screen shots in this manual may be different from the actual displays in the supplied software.
- The contents of this manual are written for users with a working knowledge of Windows®. For details on computer operations, refer to your computer manual.

About LCD display

The LCD of your CLIE handheld is designed with precision technology. However, in some cases, individual pixels may remain lit or may not light at all. Also, the brightness of the display may appear inconsistent, depending on the angle of view. Such anomalies are caused by the nature of the LCD and do not indicate a malfunction.

Please note that Sony does not guarantee a replacement or refund for such cases.

Do not expose the LCD to direct sunlight for prolonged periods of time. It may result in a malfunction. Do not store your CLIE handheld in areas subject to sunlight, such as near windows, and be careful when using outdoors.

Setting up your CLIÉ™ handheld

This chapter explains how to charge your CLIÉ handheld, perform the initial setup, and use it with your computer.

Confirming the package contents

Please confirm that all the following accessories are included in the package before setting up your CLIÉ handheld.

CLIÉ handheld (1)

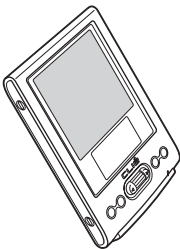

AC power adapter (1) (including AC cord)

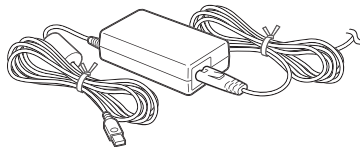

USB cable (1)

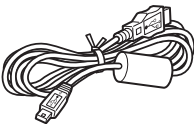

Stylus (1)



The stylus is inserted into your CLIÉ handheld at the factory.

Plug adapter (1)



Protective soft cover (1)

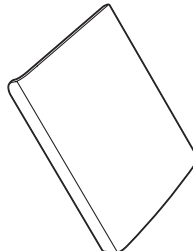

Installation CD-ROM (1)

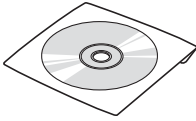

Strap (1)

Refer to the illustration below to attach the strap.

Read This First - Operating Instructions (1, this manual)

Safety & Regulations Guide (1)

Software license agreement (1)

Graffiti 2 Card (1)

Other printed materials

Make sure that the package contains all of the above contents. If any item is missing, contact the Sony Customer Information Service Center or a Sony dealer.

Use the strap to avoid dropping your CLIE handheld

Attaching the strap

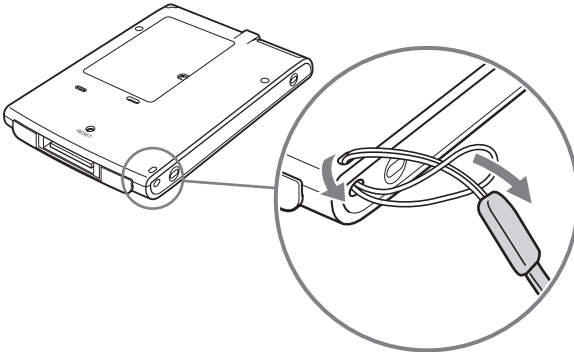

Setting up your CLIÉ™ handheld

Perform the following before setting up your CLIÉ handheld.

Step 1: Charging your CLIÉ handheld

Before using your CLIÉ handheld for the first time, make sure to fully charge the battery.

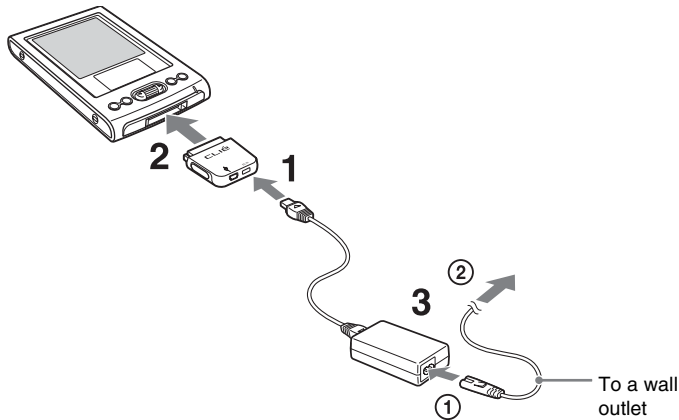

- 1** Connect the AC power adapter to the DC IN connector of the plug adapter.
- 2** Connect the plug adapter to the interface connector of your CLIÉ handheld .
- 3** Connect the AC cord to the AC power adapter (①). Then, plug the AC cord into a wall outlet (②).
The POWER LED of your CLIÉ handheld turns on when charging starts.

It takes about four hours to fully charge your CLIÉ handheld for the first time. The POWER LED turns off when charging is complete.

Tip

Subsequent charges will require less time if you charge your CLIÉ handheld frequently.

Note

If the battery of your CLIÉ handheld is completely discharged, all user data stored on your CLIÉ handheld will be lost.

How to remove the plug adapter

Remove by pressing the plug adapter on both sides as illustrated.

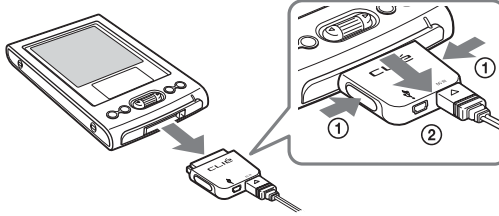

Step 2: Performing the initial setup after turning on your CLIÉ handheld for the first time

The first time you turn on your CLIÉ handheld, you need to make some initial settings. Follow the on-screen instructions to complete the initial setup and to become familiar with operations of your CLIÉ handheld.

1 Slide down the POWER/HOLD switch.

Your CLIÉ handheld turns on, and the **Setup** screen is displayed.

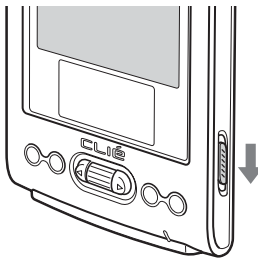

Slide down the POWER/HOLD switch

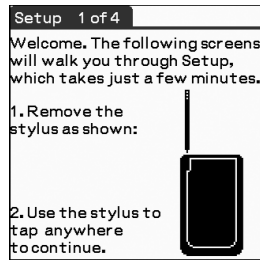

Tips

If you cannot turn on your CLIÉ handheld

- Did you charge your CLIÉ handheld as described on page 8?
 - ➔ For details, refer to “Frequently Asked Questions: I cannot turn on my CLIÉ handheld” on page 44.
- Perform a soft reset if you cannot turn on your CLIÉ handheld even after charging it (page 32).

2 Take out the stylus.

You can use the stylus to enter text or to select applications.

Take out the stylus

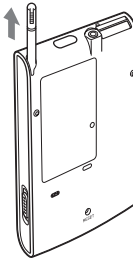

Tip

You can extend or shorten the stylus, as shown in the illustration.

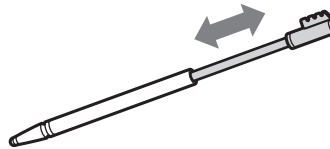

Notes

- Never use a writing pen, pencil, or other sharp object instead of the stylus to write on your CLIÉ handheld, as the screen may get scratched.
- When you put the stylus back in its holder, push it in until it clicks into place.

3 Press lightly on the screen with the stylus.

This action is called “tapping”.

The **Setup** screen for stylus digitizer is displayed.

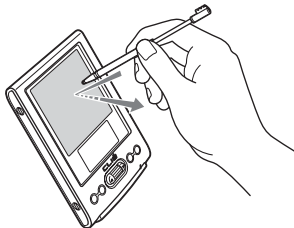

Press lightly on the screen (Tap)

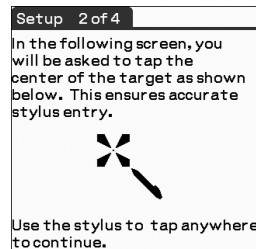

4 Following the on-screen instructions, tap exactly in the center of the displayed mark.

Tap the next targets, which are displayed at the bottom right and then in the center of the screen.

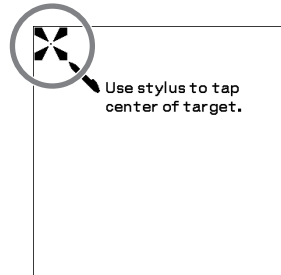

Note

If the stylus digitizer is not configured correctly, the scroll bar may not operate properly, “tapping” may not work as expected, or other problems may occur.

- ➔ For details on reconfiguring the stylus digitizer, refer to “Customizing your CLIÉ™ handheld (Preferences): Adjusting the Digitizer” in “Handbook” (PDF format).

After the stylus adjustment is complete, a screen for setting the time and date is displayed.

5 Tap the box next to [Set Time:].

The **Set Time** dialog box is displayed.

Tip

You can reconfigure the date and time settings in the **Preferences** screen.

- ➔ For details, refer to “Customizing your CLIÉ™ handheld (Preferences): Setting up the Date & Time preferences” in “Handbook” (PDF format).

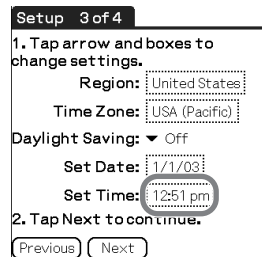

6 Tap ▲ or ▼ to set the current time.

Tap each box to set the hour and minute.

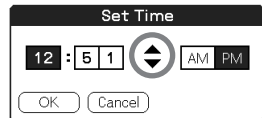

Continued on next page

7 Tap [OK].

The current time is set and the **Setup** screen is displayed.

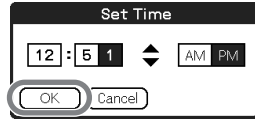

8 Tap the box next to [Set Date:].

The **Set Date** screen is displayed.

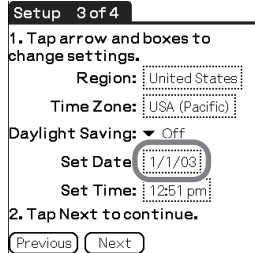

9 Tap ◀ or ▶ to select the current year.

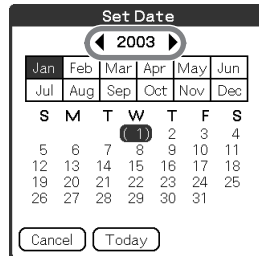

10 Tap the current month, then tap the current date.

The **Set Date** screen closes.

11 Tap the box next to [Time Zone:].

The **Set Time Zone** screen is displayed.



12 Tap the region to set the time zone, then tap [OK].



13 Tap ▼ next to [Daylight Saving:] and select [On] or [Off].

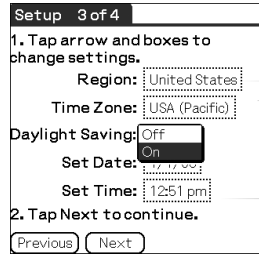

14 Tap [Next].

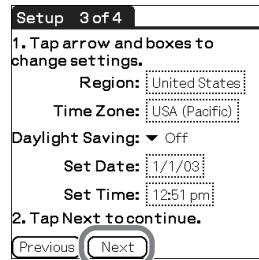

15 Tap [Next] and [Done].

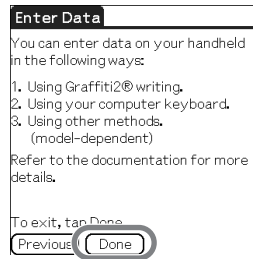
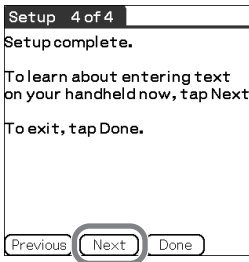

The CLIE Launcher is displayed.



The initial setup is complete.

Using your CLIÉ™ handheld with your computer

Palm™ Desktop for CLIÉ stored on the supplied Installation CD-ROM must be installed on your computer. The software is used for data transfer between your CLIÉ handheld and computer, and handling data on your computer such as **Address Book**.

➤ For details on the system requirements of computer, refer to “System requirements” on page 58.

When **Palm™ Desktop for CLIÉ** is installed on your computer, **CLIÉ Manuals** is also installed on your computer.

➤ For details on **CLIÉ Manuals**, refer to “Using CLIÉ Manuals with your computer” (page 35).

Step 1: Installing the software on your computer

Do not connect your CLIÉ handheld to your computer before installing the software. Otherwise, the software may not be installed properly.

Notes

- Do not simply copy the Palm™ Desktop for CLIÉ folder from the supplied Installation CD-ROM to your computer. To install the software properly, follow the installation procedure described below.
 - If you use Windows 2000 Professional or Windows XP, log on with a User Name in the Administrators group before installing the software.
 - If you have more than one CLIÉ handheld and the older version of **Palm™ Desktop for CLIÉ** has already been installed on your computer, follow the installation procedure below to upgrade to the new version.
 - * If you are using PEG-N710C Series or PEG-S300 Series, refer to your CLIÉ handheld support website. (Refer to the URL shown on the back cover of this manual.)
- For details, refer to “Transferring data from another CLIÉ™ handheld” in “Handbook” (PDF format).

Continued on next page

- 1 Quit all applications running on Windows®.
- 2 Insert the supplied Installation CD-ROM into the CD-ROM drive of your computer.
The **Installation CD-ROM** window is displayed.
- 3 Click [Next] or [CLIÉ Basic], then click [Install] to install **Palm™ Desktop for CLIÉ**.
The setup program starts and the **InstallShield Wizard** window is displayed.

Note

If you try to install **Palm™ Desktop for CLIÉ** when an older version of **Palm™ Desktop for CLIÉ** has already been installed on your computer, a dialog box appears on your computer window.
Follow the instruction of the dialog box to install the new version of **Palm™ Desktop for CLIÉ** supplied with your CLIÉ handheld.

- 4 Click [Next].
The **InstallShield Wizard** window for [Setup Type] is displayed.
- 5 Select the setup type, [Complete] or [Custom].
When you select [Custom], you need to specify which software you want to install and where to be installed.
The following steps explain when you select [Complete].
- 6 Click [Next].
The **InstallShield Wizard** window for [Select User] is displayed.
- 7 Enter a user name and click [Next].
The **InstallShield Wizard** window for [Ready to Install the Program] is displayed after entering any user name you prefer.

Note

If you have more than one CLIÉ handheld

Enter a user name that is different from the one you use for another CLIÉ handheld.
If you set an identical user name for multiple CLIÉ handhelds, errors may occur.

Tip

If you want to transfer data between CLIÉ handhelds

Refer to “Transferring data from another CLIÉ™ handheld” in “Handbook” (PDF format).

8 Click [Install].

Installation of **Palm™ Desktop for CLIÉ** starts.

“InstallShield Wizard Completed” message is displayed in the **InstallShield Wizard** window when the installation is complete.

9 Click [Finish].

The **Sony CLIÉ Handheld Registration** window is displayed for models for the U.S.A. and Canada only.

Tip

If you do not want to sign up for the customer service, click  to deselect [Register your CLIÉ].

Installation of Palm™ Desktop for CLIÉ on your computer is complete.

If you want to register your CLIÉ handheld, go to “Step 2: Registering your CLIÉ handheld”.

Step 2: Registering your CLIÉ handheld

You can register your CLIÉ handheld after installing **Palm™ Desktop for CLIÉ** by following the on-screen instructions.

With your permission, Sony will keep you informed of special opportunities. Also, your registration information helps Sony assist you if you call for customer support.

All of the information you provide is confidential.

Note

To register your CLIÉ handheld online, you need to have an access to the Internet.

Tip

If you want to register your CLIÉ handheld later, click  at the right top of the **Sony CLIÉ Handheld Registration** window to close.

When you complete the registration and close the **Sony CLIÉ Handheld Registration** window, the **Installation CD-ROM** window is displayed.

Other way to register your CLIÉ handheld

You can register your CLIÉ handheld online by clicking [Start], selecting [Programs] ([All Programs] for Windows XP)-[Sony Handheld]-[About PEG-TJ35_TJ25], and clicking [CLIÉ Registration].

Step 3: Connecting your CLIÉ handheld and computer via the USB cable

You can synchronize data between your CLIÉ handheld and computer by connecting them with the supplied USB cable after installing **Palm™ Desktop for CLIÉ**.

About the USB cable

The supplied USB cable has two connectors. Connect the “A” plug to the USB port of your computer and the mini “B” plug to the plug adapter.



- 1 Connect the mini “B” plug of the USB cable to the plug adapter (①), then connect the plug adapter to the interface connector of your CLIÉ handheld (②).

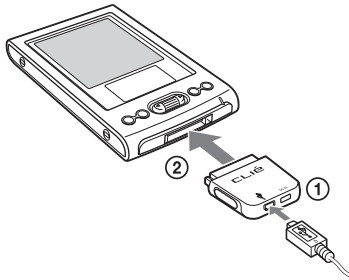

- 2 Connect the “A” plug of the USB cable to the USB port of your computer.

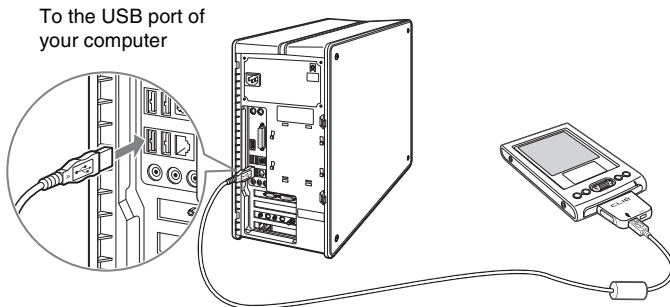

Note

Make sure to connect the USB cable directly to a USB port of your computer. If the USB cable is connected to a computer via another device, such as a USB hub, the HotSync® operation may not work properly.

Step 4: Entering a user name for your CLIÉ handheld

- 1 Rotate the Jog Dial™ navigator to select  (HotSync) on the CLIÉ Launcher and press the Jog Dial™ navigator. The **HotSync** screen is displayed.

Tip

You can also tap  (HotSync) to display the **HotSync** screen.

- 2 Tap  (HotSync) in the **HotSync** screen.

The HotSync® operation starts and the installation for the required software starts automatically.

- 3 Click [OK] when your user name is displayed in the **Users** window of your computer.

A beep is heard and the HotSync® operation starts.

Your user name entered for **Palm™ Desktop for CLIÉ** is also registered in your CLIÉ handheld.

When the setup is complete, “HotSync operation complete.” will be displayed on your CLIÉ handheld.

- 4 Click [Finish] in the **Installation CD-ROM** window of your computer.

The setup is complete.

Installing the supplied applications on your CLIÉ™ handheld

You can install applications from the supplied Installation CD-ROM by following the procedure below.

You must install **Palm™ Desktop for CLIÉ** on your computer, before installing the supplied applications on your CLIÉ handheld. Your CLIÉ handheld must be connected to your computer via the USB cable.

- ➔ For details on supplied applications, refer to “CLIÉ Application Manual” (HTML format).

Note

The supplied applications are designed to operate on your CLIÉ handheld only. Compatibility with other CLIÉ handhelds or Palm OS® PDAs is not guaranteed.

..... Installing the supplied applications from the supplied Installation CD-ROM

- 1** Quit all applications running on Windows®.
- 2** Insert the supplied Installation CD-ROM into the CD-ROM drive of your computer.
The **Installation CD-ROM** window is displayed.
- 3** Select the type of application you want to install, such as [CLIÉ Data Management].
- 4** Click [Install] to install the application.
Follow the on-screen instructions.
- 5** To install the application on your CLIÉ handheld, tap  (HotSync) in the **HotSync** screen.
The HotSync® operation starts and the selected application is transferred and installed on your CLIÉ handheld.
- 6** Click [Finish] in the **Installation CD-ROM** window of your computer.

Tip

You can also install applications on your CLIÉ handheld using the function of **Palm™ Desktop for CLIÉ**.

- ➔ For details, refer to “Enhancing features with add-on applications: Installing: Installing from your computer” in “Handbook” (PDF format).

Basic operations of your CLIÉ™ handheld

This chapter explains how to turn on/off your CLIÉ handheld, start an application, enter text, and perform a reset.

Turning on/off your CLIÉ™ handheld

Turning on your CLIÉ handheld

Slide down the POWER/HOLD switch.

Your CLIÉ handheld turns on, and the last screen you viewed is displayed.

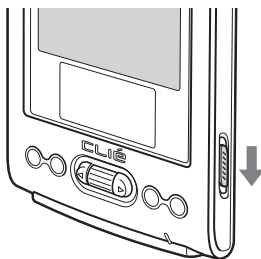

Slide down the POWER/HOLD switch

Tip

If you cannot turn on your CLIÉ handheld

Did you fully charge your CLIÉ handheld?

- For details, refer to “Frequently Asked Questions: I cannot turn on my CLIÉ handheld” on page 44.

To turn off your CLIÉ handheld

Slide down the POWER/HOLD switch again.

Starting an application

To work with your CLIE handheld, you need to start an application.

The following explains how to start applications from the CLIE Launcher using the Jog Dial™ navigator using the Jog Dial™ navigator.

Using the Jog Dial™ navigator and ◀/▶ (the Left/Right buttons)

❶ Displaying the CLIE Launcher

- 1 Tap  (Home) (page 65).
The CLIE Launcher is displayed.



❷ Selecting an application

- 1 Rotate the Jog Dial™ navigator to select an application to start.
An application is selected.

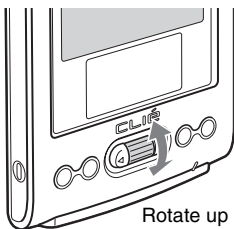

Rotate up or down



- 2** Press the Jog Dial™ navigator.
The selected application starts.

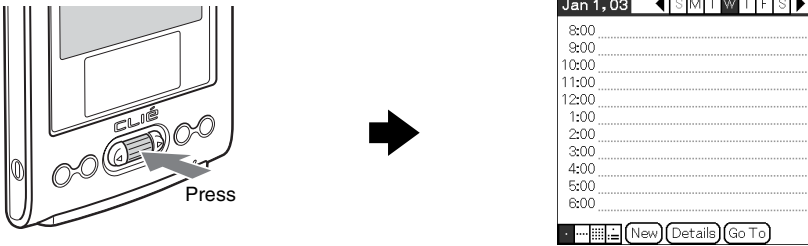

Tip

To select an application by CLIE Launcher groups

If you press ◀ (the Left button) while the CLIE Launcher is displayed, you can select the CLIE Launcher groups in the left side of the screen. Rotate the Jog Dial™ navigator to select a CLIE Launcher group, and then press ▶ (the Right button) to select an application in that CLIE Launcher group.



3 Quitting the application

You do not need to save data manually on your CLIE™ handheld as you do on a computer, although some applications require data be saved.

► For details, refer to “CLIE Application Manual” (HTML format).

To switch from one application to another, perform either of the following methods.

- **Return to the CLIE Launcher by tapping**



(Home) and start another application.

- **Press the application button (page 25) to start another application (only the application that is assigned to the application button).**

Other ways to start an application

You can also start an application using the stylus or application buttons.

Using the stylus

Start the application by pressing the screen directly with the supplied stylus.

- 1 Tap **↑** **↓** on the CLIE Launcher to display the application you want to start.



- 2 Tap the application icon.
The selected application starts.

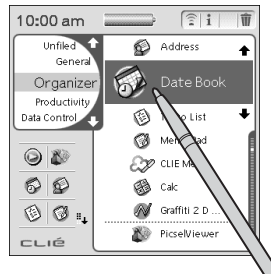

Pressing the application buttons

You can also start the applications by pressing the application buttons.

The default setting of the application buttons are:

 **Date Book**,  **Address Book**,  **To Do List**, and  **Memo Pad**.

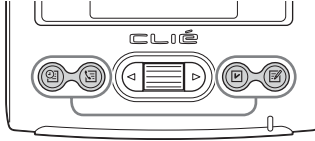

Tips

- Even when your CLIÉ handheld is off, you can start an application by pressing one of the application buttons.
- You can assign your favorite applications to the application buttons.
 - ➔ For details, refer to “Customizing your CLIÉ™ handheld (Preferences): Assigning applications to application buttons” in “Handbook” (PDF format).

Entering text

Using Graffiti® 2 writing to enter text

Graffiti® 2 is a unique writing method for quickly and easily entering text into CLIÉ applications. Text is entered in the Graffiti® 2 writing area using the supplied stylus. Graffiti® 2 recognizes your handwriting and immediately converts it to typed text.

Using the Graffiti® 2 writing area of your CLIÉ handheld

You need to write the Graffiti® 2 strokes in the Graffiti® 2 writing area in the lower screen of your CLIÉ handheld to enter text. The Graffiti® 2 writing area is divided into two parts.

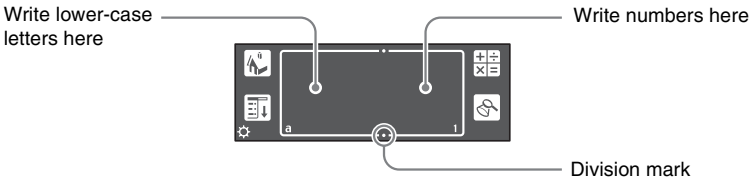

You need to write the Graffiti® 2 strokes in the left side of the Graffiti® 2 writing area for lower-case letters, the right side for numbers, or write the strokes across the division marks for upper-case letters. Also, you need to activate Symbol mode to write symbols in the Graffiti® 2 writing area.

- ➔ For details on how to write the Graffiti® 2 strokes, refer to “Entering text on your CLIÉ™ handheld: Using Graffiti® 2 writing to enter text” in “Handbook” (PDF format).

Entering text

You need to start an application and display the screen in which you want to enter text.

Follow the steps below to enter text.

- 1** Start an application, such as **Date Book**, in which you want to enter text.
- 2** Tap a line for the insertion point where text is to be entered.
- 3** Write the Graffiti[®] 2 strokes in the Graffiti[®] 2 writing area.

Displaying the on-screen Graffiti 2 Help

To assist with the Graffiti[®] 2 writing, you can display the on-screen Graffiti 2 Help by dragging the stylus from the Graffiti[®] 2 writing area in the lower part of the screen, to the top of the screen. Graffiti 2 Help opens a series of screens that show the character set of Graffiti[®] 2 writing.

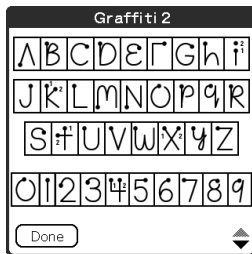
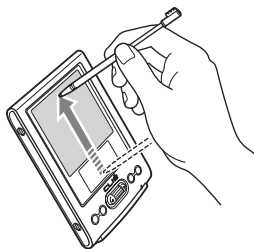

Other ways to enter text

There are some other ways to enter text into your CLIÉ handheld. You can use whichever is the most comfortable for you.

● Handwriting system

There is another way of using the handwriting system besides **Graffiti® 2**.

➔ For details, refer to “Entering text on your CLIÉ™ handheld” in “Handbook” (PDF format).

● Decuma Input (for PEG-TJ35 only)

You can enter text using **Decuma Input**, which converts your handwriting into typed text as you write.

➔ For details on **Decuma Input**, refer to “Entering text on your CLIÉ™ handheld: Using Decuma Input to enter text (for PEG-TJ35 only)” in “Handbook” (PDF format).

● On-screen keyboard

You can enter text by tapping the on-screen keyboard.

➔ For details, refer to “Entering text on your CLIÉ™ handheld: Using the on-screen keyboard to enter text” in “Handbook” (PDF format).

● The HotSync® operation with a computer

You can enter text on your computer using **Palm™ Desktop for CLIÉ** and then transfer it to your CLIÉ handheld via the HotSync® operation.

➔ For details, refer to [Help] in **Palm™ Desktop for CLIÉ**.

Synchronizing data between your CLIÉ handheld and computer (the HotSync® operation)

What is the HotSync® operation?

The HotSync® operation is an easy operation that allows you to synchronize data between your CLIÉ handheld and computer, back up the data of your CLIÉ handheld to your computer, and install add-on applications.

► For details, refer to “Exchanging and updating files/data using the HotSync® operation (Other HotSync® operations)” in “Handbook” (PDF format).

Performing the HotSync® operation

The following procedure explains how to synchronize data between your CLIÉ handheld and computer, using **Date Book** as an example.

- 1 Turn on your computer.
- 2 Enter a new schedule event in **Date Book** of your CLIÉ handheld.
► For details on entering schedule events in **Date Book**, refer to “Managing schedule events (Date Book)” on page 8 in “Applications Guide” (PDF format).
- 3 Connect your CLIÉ handheld and computer via the supplied USB cable (page 18).
- 4 Rotate the Jog Dial™ navigator to select  (HotSync) on the CLIÉ Launcher and press the Jog Dial™ navigator. The **HotSync** screen is displayed.

Tip

You can also tap  (HotSync) to display the **HotSync** screen.

5 Tap  (HotSync) in the **HotSync** screen.

The HotSync[®] operation starts.

When the HotSync[®] operation is complete, the following screen is displayed.

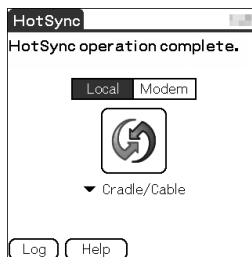

6 Double-click  (Palm Desktop for CLIÉ) on the Windows desktop.

Palm™ Desktop for CLIÉ starts and the Date Book window is displayed. If you select the same date you entered in Step 2, you will see the schedule for that day.

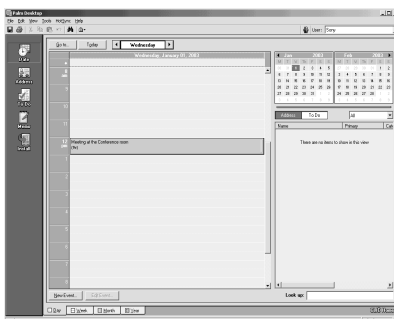

Tip

You can also click [Start], select [Programs] ([All Programs] for Windows XP)-[Sony Handheld], and click [Palm Desktop for CLIÉ] to start the software.

To display other application windows (Address Book, To Do List, and Memo Pad)

Click any icon on the left side of the window.

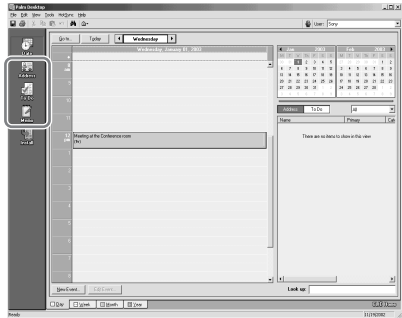

Making a backup is recommended

If problems occur, even those requiring a hard reset, you can restore your CLIÉ handheld to the same state as it was at the last HotSync® operation.

You may not be able to back up certain add-on applications installed after the initial setup or the data created by them.

- For backup details, refer to “Making a backup of the data or applications on your CLIÉ handheld” on page 41.

Restarting your CLIÉ™ handheld

Normally, you do not need to reset your CLIÉ handheld. However, if your CLIÉ handheld does not turn on or respond, performing a soft reset may solve the problem.

To reset your CLIÉ handheld, follow the procedure below.

.....

Performing a soft reset

All records and add-on applications stored on your CLIÉ handheld are retained even after performing a soft reset.

Gently press the RESET button with the stylus.

The system shuts down and your CLIÉ handheld restarts.

After restarting, it displays “palm POWERED”, “SONY” and “CLIÉ”, followed by the **Preferences** screen for setting up the time and date.

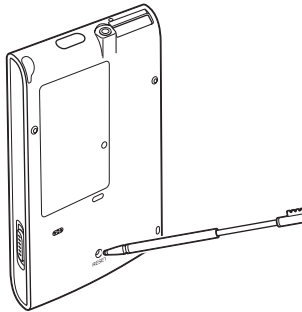

Notes

- After the RESET button is pressed, it takes a while before the **Preferences** screen is displayed. Do not press the RESET button again while resetting.
- Do not press the RESET button with anything other than the stylus, as a malfunction may occur.

Performing a hard reset

If the soft reset does not solve the problem, you may need to perform a hard reset to restart your CLIE handheld.

Notes

- **All records and add-on applications stored on your CLIE handheld will be erased by performing a hard reset.**
 - Perform a hard reset only if a soft reset does not solve the problem. However, you can restore the data if you have made a backup on your computer via the HotSync® operation*.
 - * Note that some data cannot be backed up.
- ➔ For details, refer to “Backing up your CLIE™ handheld data and applications” in “Handbook” (PDF format).

- 1** Slide down and hold the POWER/HOLD switch.
- 2** Press the RESET button gently with the stylus, and then release the stylus.

Note

Keep the POWER/HOLD switch held down.

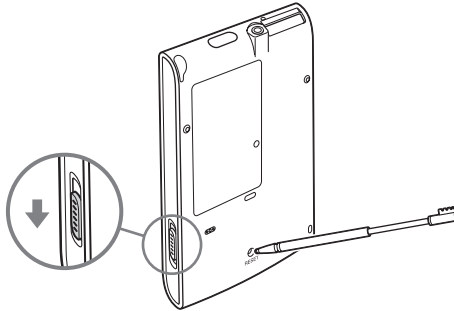

- 3** Wait for more than three seconds after the **palm POWERED** screen is displayed, and release the POWER/HOLD switch.

A message “Erase all data?” is displayed.

4 Press ◀ (the Left button) on your CLIÉ handheld.

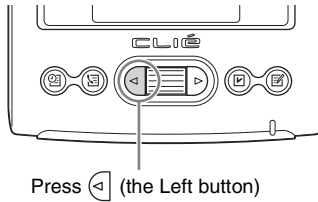

Tip

If you want to cancel the hard reset, press any button other than ◀ (the Left button).

The hard reset is performed.

After restarting, your CLIÉ handheld displays “palm POWERED”, “SONY” and “CLIÉ”, followed by the **SETUP** screen. Refer to “Step 2: Performing the initial setup after turning on your CLIÉ handheld for the first time” on page 9 for the initial setup.

After a hard reset, only the current date and time are retained. Formats, Preferences, and other controls revert to the factory settings.

Notes

- After the RESET button is pressed, it takes a while before the **Setup** screen is displayed. Do not press the RESET button again while resetting.
- If ◀ (the Left button) is not pressed long enough, the hard reset may not be performed.

Using CLIÉ Manuals with your computer

You can also use the other manuals of your CLIÉ handheld that are stored on the supplied Installation CD-ROM. The manuals are to be read on your computer.

Note

Prior to using the manuals, refer to “Step 1: Installing the software on your computer” on page 15 to install **Palm™ Desktop for CLIÉ**. **CLIÉ Manuals** will be installed at the same time.

Manuals Overview

You can read each manual installed on your computer to use your CLIÉ handheld more effectively.

How to use the supplied applications



Applications Guide

“Applications Guide” is a PDF format manual. It introduces the supplied applications and briefly explains how to use them.

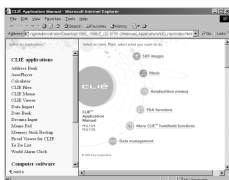

CLIÉ Application Manual

“CLIÉ Application Manual” is a HTML format manual. It explains how to use the supplied applications in detail.

How to perform basic operations and to use advanced features of your CLIÉ handheld

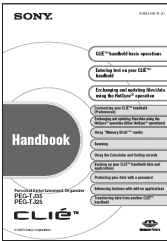

Handbook

“Handbook” is a PDF format manual.

It explains the basic operations and advanced features of your CLIÉ handheld in detail.

How to solve problems you may have

If you have any problems while using your CLIÉ handheld, refer to “Frequently Asked Questions” on page 42 first.

If the problem persists, read “Troubleshooting Q&A” to solve the problem.

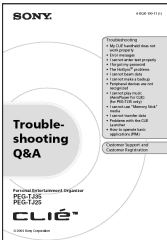

Troubleshooting Q&A

“Troubleshooting Q&A” is a PDF format manual.

It helps solve common problems that you may have while using your CLIÉ handheld.

Opening CLIÉ Manuals

Follow the steps below to open **CLIÉ Manuals**.

- 1 Double-click  (CLIÉ Manuals PEG-TJ35_PEG-TJ25) on the Windows desktop.
The **CLIÉ Application Guide PEG-TJ35/PEG-TJ25** window is displayed.

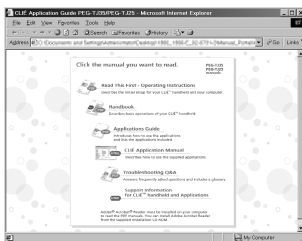

Tip

You can also click [Start], select [Programs] ([All Programs] for Windows XP)-[Sony Handheld]-[About PEG-TJ35_PEG-TJ25], and click [CLIÉ Manuals] to start **CLIÉ Manuals**.

- 2 Click any manual you want to read.
The selected manual is displayed.

Note

To read the PDF manuals, **Adobe Acrobat Reader** must be installed on your computer. If it is not installed on your computer, you can install it from the supplied Installation CD-ROM.

➔ For details on how to use PDF manuals or installation, refer to “Reading the PDF manuals on your computer” (page 38).

Reading the PDF manuals on your computer

The following explains how to read the PDF format manuals on your computer.

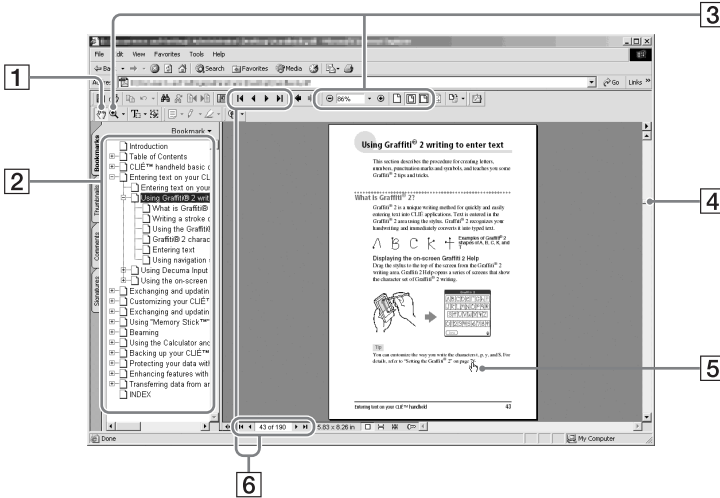

- 1 Use Hand Tool to scroll the displayed page.
- 2 Bookmarks are displayed. Click each title to display the page. Click **+** to display the directories of the chapters.
- 3 Buttons for zooming in/out the page.
- 4 Click here and drag to scroll the page.
- 5 You can display the linked page by clicking a point where  is displayed.
- 6 Buttons for displaying the previous or next page. You can also enter a page number you want to display at the bottom of the page number area.

..... Installing Adobe Acrobat Reader on your computer

If **Adobe Acrobat Reader** is not installed on your computer, follow the steps below to install it.

- 1 Quit all applications running on Windows®.
- 2 Insert the supplied Installation CD-ROM into the CD-ROM drive of your computer. The **Installation CD-ROM** window is displayed.

- 3 Click [CLIÉ Basic] in the left side of the window.
- 4 Click [Install] to install **Adobe Acrobat Reader**. Follow the on-screen instructions.
- 5 Click [Finish].
The **Installation CD-ROM** window closes.

Reading the HTML manual on your computer (CLIÉ Application Manual)

The following explains how to read the HTML format manual on your computer.

Note

You need Microsoft Internet Explorer version 5.0 or later to display “CLIÉ Application Manual” properly.

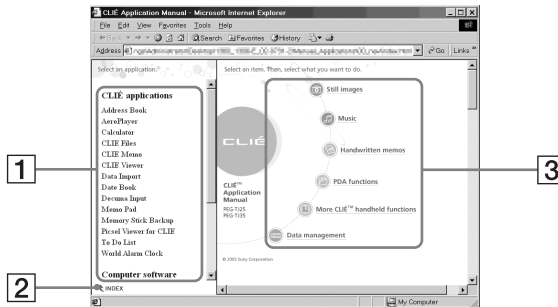

- 1 Click any application to display the explanation in detail.
- 2 Click to display the index of the supplied applications.
- 3 Click any application group to display the group. Then you can select a desired application from that group to display further instructions.

Troubleshooting

If you have problems, please follow the procedure below.
Make note of any messages or alerts that are displayed.

Step 1: Refer to this manual, “Troubleshooting Q&A”, or the manual of each application

- Read “Frequently Asked Questions” on page 42.
- Refer to “Troubleshooting Q&A” (PDF format).
- Click  (CLIÉ Manuals PEG-TJ35_PEG-TJ25) on the Windows desktop for more information on applications.

Step 2: Refer to the Sony CLIÉ handheld Support website

Double-click  (CLIÉ Info) on the Windows desktop, and select [CLIÉ™ Handheld Support].

Note

Thousands of third party add-on applications are available for the Palm OS® platform. Sony does not support third party applications. If you are having problems with a third party application, please contact the publisher of that application.

Making a backup of the data or applications on your CLIÉ handheld

Sony recommends that you make a backup of your data in case of unexpected problems. Backing up your data will ensure that it can be restored again on your CLIÉ handheld, even if you have to perform a hard reset.

Making a backup using Memory Stick Backup

Use “Memory Stick” media and **Memory Stick Backup** on your CLIÉ handheld to back up data and applications on your CLIÉ handheld.

► **“Memory Stick” media (sold separately) is required.**

For details, refer to “Backing up your CLIÉ™ handheld data and applications: Backing up data and applications to “Memory Stick” media using Memory Stick Backup” in “Handbook” (PDF format).

Making a backup using the HotSync® operation

Data or applications on your CLIÉ handheld is backed up to your computer when the HotSync® operation is performed. If you need to perform a hard reset, this would erase all user data and applications stored on your CLIÉ handheld. However, the erased data and applications can be restored with the next HotSync® operation.

Notes

- Some add-on applications (not installed at the factory), and some application data and settings may not be backed up using the HotSync® operation. However, a complete backup of all data on your CLIÉ handheld can be made with **Memory Stick Backup**. Use **Memory Stick Backup** often to make complete backups.
- When you need to restore data, and so on, make sure that you perform the HotSync® operation immediately after you perform a hard reset. Otherwise, if you create new data on your CLIÉ handheld between the hard reset and performing the HotSync® operation, the data may be lost.

Frequently Asked Questions

If the solutions mentioned in this section do not solve your problem, refer to “Troubleshooting Q&A” (PDF format).

My CLIÉ handheld does not work properly (page 44)

- I cannot turn on my CLIÉ handheld
- The screen is not displayed even though the POWER LED is on
- My CLIÉ handheld does not respond
- My CLIÉ handheld keeps turning itself off
- My CLIÉ handheld does not produce any sounds
- The backlight does not turn on when I adjust the brightness level
- The LCD display cannot be viewed properly
- Applications do not operate properly after a soft reset is performed
- I cannot use the Jog Dial™ navigator

Error messages (page 46)

- An error message appears repeatedly
- The message “Invalid process” appears when an application is started

I cannot enter text properly (page 46)

- My CLIÉ handheld does not recognize handwritten characters (when using **Graffiti® 2**)
- My CLIÉ handheld does not recognize handwritten characters (when using **Decuma Input**)

The HotSync® problems (page 47)

- I cannot perform the local HotSync® operation
- I cannot start the HotSync® operation by tapping  (HotSync) on the **HotSync** screen
- I cannot cancel the HotSync® operation midway
- It takes a long time to complete the HotSync® operation
- Data cannot be synchronized with some applications when the HotSync® operation is performed
- I cannot back up some data using the HotSync® operation

- **Palm™ Desktop for CLIE** does not start or cannot be selected from the menu
- **HotSync Manager** does not start.  (HotSync) is not displayed in the task tray (Notification area) at the bottom right of my computer window

I cannot play music (for PEG-TJ35 only) (page 51)

- MP3 files cannot be read or played

I cannot use “Memory Stick” media (page 51)

- My CLIE handheld does not recognize “Memory Stick” media, or an error occurs

My CLIÉ handheld does not work properly

I cannot turn on my CLIÉ handheld

- ▶ Is the POWER/HOLD switch of your CLIÉ handheld in HOLD mode (page 61) ?
Your CLIÉ handheld does not work when the POWER/HOLD switch is in HOLD mode. Make sure you release HOLD mode.
- ▶ Has the battery power of your CLIÉ handheld run out?
Connect your CLIÉ handheld to the AC power adapter with the plug adapter, then allow it to be charged for a few minutes before turning it on. If it turns on, continue charging for approximately four hours and then perform a soft reset.
- ▶ Is the connector between your CLIÉ handheld and the plug adapter dirty?
You cannot charge your CLIÉ handheld if the connector is dirty. Connect and disconnect your CLIÉ handheld and the plug adapter several times to clean the connector.
- ▶ Perform a soft reset by pressing the RESET button at the back of your CLIÉ handheld (page 32).

The screen is not displayed even though the POWER LED is on

- ▶ Is the POWER/HOLD switch of your CLIÉ handheld in HOLD mode (page 61) ?
The screen is not displayed when the POWER/HOLD switch is in HOLD mode. Make sure you release HOLD mode.
- ▶ Perform a soft reset by pressing the RESET button at the back of your CLIÉ handheld (page 32).

My CLIÉ handheld does not respond

- ▶ Is the POWER/HOLD switch of your CLIÉ handheld in HOLD mode (page 61) ?
Your CLIÉ handheld does not operate when the POWER/HOLD switch is in HOLD mode. Make sure you release HOLD mode.
- ▶ Is your CLIÉ handheld placed near the IR port of your computer?
Move your CLIÉ handheld away from the IR port of your computer except when performing the IR HotSync[®] operation, as a malfunction may occur. You can also disable the IR feature by selecting [Off] next to [Beam Receive:] in [General] of the **Preferences** screen.
- ▶ Perform a soft reset by pressing the RESET button at the back of your CLIÉ handheld (page 32).

My CLIÉ handheld keeps turning itself off

- ▶ Your CLIÉ handheld is designed to turn itself off after a period of inactivity (Automatic power-off). You can set the automatic power-off time by selecting time for [Auto-off After:] in [General] of the **Preferences** screen.
 - For details, refer to “Customizing your CLIÉ™ handheld (Preferences): Setting the automatic power-off time” in “Handbook” (PDF format).
- ▶ Did you set [After a preset delay] from [Auto Lock Handheld:] in the **Security** screen? If you set [After a preset delay] from [Auto Lock Handheld:], your CLIÉ handheld may turn off after a shorter period even if you set the automatic power-off time.
 - For details, refer to “Protecting your data with a password: Locking your CLIÉ handheld with a password (Data protection)” in “Handbook” (PDF format).

My CLIÉ handheld does not produce any sounds

- ▶ Is [System Sound:] in [General] of the **Preferences** screen set to [Off]?
 - For details, refer to “Customizing your CLIÉ™ handheld (Preferences): Setting sounds” in “Handbook” (PDF format).
- ▶ Adjust the volume settings in the **Adjust Volume** dialog box displayed by tapping  in the **Status Info** dialog box (page 67).

Tip

If [Muting]* is selected in the **Adjust Volume** dialog box, all sounds, including audio, are muted.

* [Muting] is available for PEG-TJ35 only.

- For details, refer to “CLIÉ™ handheld components: Status Information” (page 67).

The backlight does not turn on when I adjust the brightness level

- ▶ If the brightness is set to the lowest level, the display may be illegible. However, this is not a malfunction.

The LCD display cannot be viewed properly

- ▶ Depending upon the angle of vision, the brightness may be uneven, however, this is not a malfunction. You can adjust the brightness level in the **Adjust Brightness** dialog box displayed by tapping  (page 65) at the bottom left of the Graffiti 2 writing area. If the backlight is off, you can turn it on by sliding down the POWER/HOLD switch and hold it for more than two seconds.

Applications do not operate properly after a soft reset is performed

- ▶ If you encounter application problems (such as improper operations, unusual display, or freezing during a soft reset) after you performed a reset, the reset may not be completed properly. In such a case, perform a soft reset once again (page 32). If you still cannot solve your problem, try a hard reset (page 33).

Note on performing a reset

After performing a reset, do not press the RESET button at the back of your CLIÉ handheld again until the **Preferences** screen or the **Setup** screen is displayed.

I cannot use the Jog Dial™ navigator

- ▶ The Jog Dial™ navigator (page 60) is not available for some applications.

Error messages

An error message appears repeatedly

- ▶ Perform a soft reset by pressing the RESET button at the back of your CLIÉ handheld (page 32).

The message “Invalid process” appears when an application is started

- ▶ If there is insufficient memory space in your CLIÉ handheld or “Memory Stick” media, applications may not work properly. Delete any unnecessary data/files.

I cannot enter text properly

My CLIÉ handheld does not recognize handwritten characters (when using Graffiti® 2)

- ▶ To have your CLIÉ handheld recognize handwritten characters entered with the stylus, you must use Graffiti® 2.
 - ➔ For details, refer to “Entering text on your CLIÉ™ handheld: Using Graffiti® 2 writing to enter text” in “Handbook” (PDF format).
- ▶ Make sure you enter the Graffiti® 2 strokes in the Graffiti® 2 writing area (page 66).
- ▶ Make sure you enter the Graffiti® 2 strokes for letters in the left side of the Graffiti® 2 writing area and numbers in the right side (page 66).
- ▶ Check that Graffiti® 2 is not shifted into Symbol mode.
 - ➔ For details, refer to “Entering text on your CLIÉ™ handheld: Using Graffiti® 2 writing to enter text” in “Handbook” (PDF format).

- ▶ If the letter “L” is registered as a menu command for an application, the letters “K”, “T”, “I”, and “X” will not work as menu command.
- ▶ How to enter Graffiti[®] 2 characters faster and more accurately.
 - For details, refer to “Entering text on your CLIÉ™ handheld: Using Graffiti[®] 2 writing to enter text” in “Handbook” (PDF format).

My CLIÉ handheld does not recognize handwritten characters (when using Decuma Input)

- ▶ Refer to “Decuma Input” in “CLIÉ Application Manual” (HTML format) and try writing again using **Decuma Input**.
- ▶ If your handwriting cannot be recognized correctly as numbers or special characters in General characters mode, switch the Decuma Input area from General characters mode to Numbers and special characters mode.
 - For details, refer to “Entering text on your CLIÉ™ handheld: Using Decuma Input to enter text” in “Handbook” (PDF format).

The HotSync[®] problems

I cannot perform the local HotSync[®] operation

Verifying your CLIÉ handheld



- ▶ Is the connector between your CLIÉ handheld and the plug adapter dirty?
Connect and disconnect your CLIÉ handheld and the plug adapter several times to clean the connector.
- ▶ Are your CLIÉ handheld with the plug adapter and the USB cable properly connected (page 18)?
- ▶ Is there sufficient memory space of your CLIÉ handheld?
Delete any unnecessary data/files and then perform the HotSync[®] operation again.
- ▶ Are you using the same user name that is used for another CLIÉ handheld?
Change the user name.

Verifying your computer

- ▶ Is Palm™ Desktop for CLIÉ installed?
- ▶ Is the operating system on your computer compatible?
The following operating systems are compatible with your CLIÉ handheld. Operating systems other than the following are not supported.
 - Microsoft Windows 98 Second Edition
 - Microsoft Windows 2000 Professional
 - Microsoft Windows Me
 - Microsoft Windows XP

Note

Upgrade versions of operating systems are not supported.

- ▶ If you are using Windows 2000 Professional or Windows XP, log in as an “Administrator.”
- ▶ Is the USB cable properly connected to your computer (page 18)?
- ▶ Is  (HotSync) displayed in the task tray (Notification area) at the bottom right of your computer window?
If not, click [Start], select [Programs] ([All Programs] for Windows XP)-[Sony Handheld], and click [HotSync Manager] to start **HotSync Manager**.
- ▶ Is [Local USB] in the shortcut menu selected? (You can display this by clicking  (HotSync) in the task tray (Notification area).)
If not, select [Local USB].
- ▶ Is the USB port active?
Check whether the USB port works normally by connecting another USB device, such as a USB mouse.
- ▶ If you use an extended terminal devices for laptop computers, such as a port replicator, you may not be able to use either the port replicator or the USB port of your computer.
- ▶ Quit all applications other than **Palm™ Desktop for CLIE**.

If you cannot perform the HotSync® operation even after following the above instructions, perform a soft reset by pressing the RESET button at the back of your CLIE handheld (page 32).

For particular problems regarding the HotSync® operations, refer to the following.

I cannot start the HotSync® operation by tapping (HotSync) on the HotSync screen

- ▶ Ensure [Local] and [Cradle/Cable] are selected in the **HotSync** screen.
- ▶ Perform a soft reset by pressing the RESET button at the back of your CLIE handheld (page 32).

I cannot cancel the HotSync® operation midway

- ▶ You may not be able to stop the HotSync® operation by tapping [Cancel] for over ten seconds after you start the USB HotSync® operation. Try again after a while.
- ▶ If you disconnect your CLIE handheld and computer during the HotSync® operation, the HotSync® operation may not perform correctly.
In such a case, perform a soft reset (page 32).
- ▶ If you cannot stop the HotSync® operation even by tapping [Cancel], perform a soft reset (page 32).

It takes a long time to complete the HotSync® operation

- ▶ Depending on the application you are using, it may require time to complete the HotSync® operation because of large data/file sizes.

Data cannot be synchronized with some applications when the HotSync® operation is performed

- ▶ Does the user name for **Palm™ Desktop for CLIÉ** match the one for your CLIÉ handheld?
In **Palm™ Desktop for CLIÉ**, select the user name corresponding to your CLIÉ handheld user name.
- ▶ Is the application set not to synchronize files?
Click  (HotSync) in the task tray (Notification area) at the bottom right of your computer window and select [Custom...] from the shortcut menu. Check that the application is set to synchronize files.
- ▶ Is third party backup or synchronization software installed on your computer or CLIÉ handheld?
In such a case, you may not synchronize some applications using **Palm™ Desktop for CLIÉ**.
- ▶ Is there sufficient memory space in your CLIÉ handheld?
Delete unnecessary data/files and then perform the HotSync® operation again.
- ▶ Is private data hidden in the **Security** screen?
Hidden data cannot be displayed in **Palm™ Desktop for CLIÉ**. When you want to display hidden data, select [Show Records] below [Current Privacy:] in the **Security** screen and enter the password.
- ▶ Make sure that **Intellisync Lite** is installed to synchronize **Date Book**, **Address Book**, **To Do List** and **Memo Pad** of your CLIÉ handheld with **Microsoft® Outlook** or **Lotus Organizer**.
 - For details, refer to “Intellisync Lite” in “CLIÉ Application Manual” (HTML format).

I cannot back up some data using the HotSync® operation

- ▶ Some add-on applications (not installed at the factory), and some application data and settings may not be backed up using the HotSync® operation. However, a complete backup of all data on your CLIÉ handheld can be made with **Memory Stick Backup**. Use **Memory Stick Backup** often to make complete backups.
 - For details, refer to “Backing up your CLIÉ™ handheld data and applications: Backing up data and applications to “Memory Stick” media using Memory Stick Backup” in “Handbook” (PDF format).

Palm™ Desktop for CLIÉ does not start or cannot be selected from the menu

- ▶ Is **Palm™ Desktop for CLIÉ** properly installed on your computer?
The hardware or the software of your computer may not be compatible with **Palm™ Desktop for CLIÉ**. Uninstall **Palm™ Desktop for CLIÉ** and reinstall it.



HotSync Manager does not start. (HotSync) is not displayed in the task tray (Notification area) at the bottom right of my computer window

► Reinstall **Palm™ Desktop for CLIÉ**.

If you still cannot perform the HotSync® operation

If you cannot solve your HotSync® operation problem by following the troubleshooting tips in this manual, follow the procedure below.

Check if any “Unknown device” is listed in the Device Manager on your computer.

- 1 Right-click [My Computer] and select [Properties] from the menu.
The **System Properties** window is displayed.
 - 2 If you are using Windows 2000 Professional/Windows XP, click [Hardware].
 - 3 Click [Device Manager].
 - 4 Check if there is a device marked with  or .
- A device with such mark is not operating normally. Contact the manufacturer of the device to get information on the latest device drivers.

You cannot perform the HotSync® operation before you install Palm™ Desktop for CLIÉ on your computer

If you perform the HotSync® operation before you install the CLIÉ handheld drivers on your computer, other drivers may be installed on your computer and a problem may occur in your computer system.

Make sure you install **Palm™ Desktop for CLIÉ** before performing the HotSync® operation.

Do not use a USB hub

If you connect your CLIÉ handheld to your computer via a USB hub, you may not be able to perform the HotSync® operation properly. Make sure you connect the USB cable directly to a USB port of your computer.

Some computers have the hub function built into their internal circuitry. Contact your computer manufacturer to check whether the USB port of your computer is connected to an internal USB hub.

Check that the USB port of your computer is enabled

If you are using a Windows 95 pre-installed computer or other older type of computer equipped with a USB port, the USB port may be disabled by default. Test the USB port with another device, such as a USB mouse. If that device does not work, check the BIOS setting of your computer.

In addition, check the setting in the Device Manager: Right-click [My Computer] and select [Properties] from the menu. (If you are using Windows 2000 Professional/Windows XP, click [Hardware].) Click [Device Manager] and check that [USB controller] is displayed in the **Device Manager** window.

If USB controller is not displayed

- ➔ For details, refer to the manual of your computer.

I cannot play music (for PEG-TJ35 only)

MP3 files cannot be read or played

- ▶ Check that the MP3 files are located in [PALM/Programs/MSAUDIO] directory on the “Memory Stick” media.

To play the MP3 files located in other directories, select [File] in the **Settings** screen, which can be displayed by selecting [Settings...] from [Options] in the menu of **AeroPlayer for CLIE**, and select [Search entire card].

[Search one folder] is set by default.

- ➔ For details on file formats supported by your CLIE handheld, refer to “AeroPlayer for CLIE” in “CLIE Application Manual” (HTML format).

I cannot use “Memory Stick” media

My CLIE handheld does not recognize “Memory Stick” media, or an error occurs

- ▶ Remove the “Memory Stick” media and try inserting it again.
- ▶ If the terminal part of the “Memory Stick” media is dirty, your CLIE handheld cannot read the data/files. Wipe the terminal with a soft cloth, such as a cotton pad.
- ▶ You cannot use “Memory Stick” media that is formatted in a device other than your CLIE handheld. Format it on your CLIE handheld.
- ▶ When the battery power of your CLIE handheld is running low, data/files on “Memory Stick” media may not be displayed. Charge the battery of your CLIE handheld.

Customer Support and Customer Registration

- **For customer support information**

Double-click  (CLIÉ Info) on the Windows desktop, and select [CLIÉ™ Handheld Support].

- **For online customer registration (For customers in the U.S.A. and Canada only)**

Double-click  (CLIÉ Info) on the Windows desktop, and select [Sony CLIÉ™ Registration].

Notes on use

..... Handling your CLIÉ handheld

- Make sure you do not scratch or damage your CLIÉ handheld's screen. Always use the supplied stylus to tap on the screen. Do not use a writing pen, pencil, or other sharp object on the screen.
- Do not expose your CLIÉ handheld to rain or moisture. Should water enter the circuitry through the buttons and switches, your CLIÉ handheld may be damaged.
- Your CLIÉ handheld's screen is made of glass. Do not drop or submit your CLIÉ handheld to excessive shock. Do not carry your CLIÉ handheld in your pocket. If you sit down with your CLIÉ handheld in the pocket, your CLIÉ handheld may break.
- Avoid using or storing your CLIÉ handheld in locations subject to:
 - extremely high temperatures, such as inside a car exposed to the sun, or near a heater.
 - direct sunlight
 - high humidity
 - excessive dust

Cleaning your CLIÉ handheld

Clean your CLIÉ handheld with a soft, dry cloth.

Cleaning the stylus

Tapping or dragging the screen with a dirty stylus may damage the screen surface.

Wipe the stylus with a dry cloth when it gets dirty.

.....

Battery considerations

Battery safety

To avoid battery leakage, heat generation, firing, or bust, observe the following:

- Do not use any other type of battery in your CLIÉ handheld.
- Do not charge the battery in any other way than as specified in this manual.
- Do not throw the battery into fire.
- Do not attempt to short-circuit the battery.
- Do not take the battery apart.
- Do not modify the battery.
- Do not heat the battery in an oven or micro wave.
- Do not charge the battery near an open flame or in direct sunlight.
- Do not leave the battery in a car.
- Do not subject your CLIÉ handheld or the battery to excessive shock.
- Take care not to drop your CLIÉ handheld, give pressure to it with a sharp object, or crush with a heavy object.
- If you have skin contact with battery leakage or get some in your eye, wash with water immediately and consult a doctor.

Charging

- It takes approximately four hours to charge your CLIÉ handheld when the battery is empty.
- If you charge your CLIÉ handheld every day, it takes only a few minutes to charge the battery.
- You can operate your CLIÉ handheld while the battery is being charged.

Battery life

Battery life varies depending on the conditions and environment where you use your CLIÉ handheld and applications used.

- ➔ For details about battery life, refer to “Specifications” on page 57.

Conserving the battery

- Turn off the backlight under good lighting conditions.
 - ➔ For details on the backlight, refer to “POWER/HOLD switch” on page 62.
- Change the automatic power-off time setting so that your CLIÉ handheld will automatically turn off after a short period of inactivity.
 - ➔ For details, refer to “Customizing your CLIÉ™ handheld (Preferences): Setting the automatic power-off time” in “Handbook” (PDF format).

Using peripheral devices

If a low battery warning is displayed while using peripheral devices, change your CLIÉ handheld immediately. If you continuously use it, it automatically turns off and cannot operate until you charge it.

When the battery power gets low

- When the battery power gets low, a warning message is displayed on the screen, “Memory Stick” media becomes inaccessible, and the backlight adjustment no longer operates. If this occurs, connect your CLIÉ handheld to wall outlet and perform the HotSync® operation.
- If your CLIÉ handheld does not turn on when you slide down the POWER/HOLD switch, charge your CLIÉ handheld immediately.
- The remaining battery indicator may not always reflect the actual battery power. To prevent loss of battery power, charge your CLIÉ handheld frequently.
- You do not have to replace batteries. When battery power gets low, charge your CLIÉ handheld immediately. Never disassemble your CLIÉ handheld to take out the battery.

Do not let the remaining battery power indicator reach 0

If you leave your CLIÉ handheld in an uncharged state (the remaining battery power indicator reaches 0 ) , all user data stored on your CLIÉ handheld will be erased. To avoid this, you should charge your CLIÉ handheld frequently.

Other information

Your CLIÉ handheld may get warm if turned on for long periods of time. This is not a malfunction.

About replacing the battery

CAUTION

Please contact with your nearest Sony dealer in connection with this product with problem.

Recycling Lithium-Ion batteries

The following information for recycling batteries is ONLY intended for customers in the U.S.A. and Canada.

Lithium-Ion batteries are recyclable.

You can help preserve our environment by returning your used rechargeable batteries to the collection and recycling location nearest you.

For more information regarding recycling of rechargeable batteries, call toll free 1-800-822-8837, or visit the website (<http://www.rbrcc.org/>).

When you dispose of your CLIÉ handheld, remove the battery for recycling.

How to remove a rechargeable button battery

Note

Remove the battery only when you dispose of your CLIÉ handheld.

- 1** Remove the screw from the back of your CLIÉ handheld with a Phillips screwdriver.
- 2** Remove the battery cover.

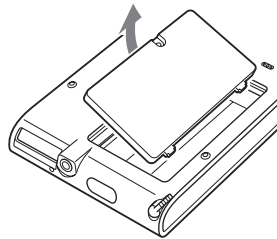
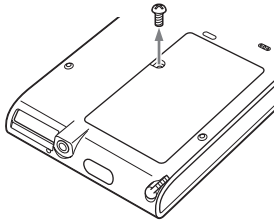

- 3** Lift up the battery from your CLIÉ handheld.
- 4** Disconnect the cord by pulling the battery.

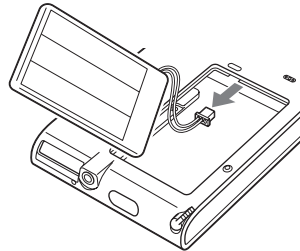
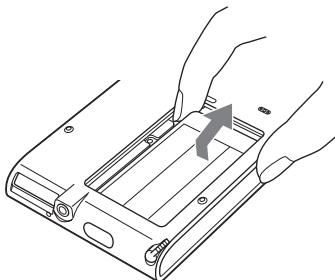

Do not damage the removed battery.

Specifications

OS

Palm OS® 5 (Ver.5.2.1)

CPU

i.MXL Application Processor

Memory

PEG-TJ35: 32 MB (RAM)

User memory available:

Approx. 23 MB

PEG-TJ25: 16 MB (RAM)

User memory available:

Approx. 11 MB

External input/output

Interface connector

IrDA (1.2)

“Memory Stick” slot

Display

TFT color display with backlight,

320 × 320 dots, 65,536 colors

Other functions

Monaural Speaker

(for PEG-TJ35 only)

Buzzer*

(for PEG-TJ25 only)

* There is no operating sound when you turn on your CLiÉ handheld for the first time or restart it.

Dimensions (excluding projections)

Approx. $3 \times 4 \frac{3}{8} \times \frac{15}{32}$ inches

(75.3 × 110.1 × 11.9 mm) (w/h/d)

Weight

PEG-TJ35: Approx. 4.9 oz (140 g)

PEG-TJ25: Approx. 4.9 oz (140 g)

(including the supplied stylus)

Operating temperature

41 °F to 95 °F (5 °C to 35 °C)

Power requirements

AC power adapter (supplied):

DC 5.2 V (dedicated connector)

(Use an appropriate AC cord from the supplied AC cords)

Battery:

Lithium-ion battery

Battery life

Operating PIMs (Personal Information Management applications):

Approx. 10 days

(when PIMs, such as **Date Book**, are operated for 30 minutes per day with the backlight off)

Approx. 5.5 days

(when PIMs, such as **Date Book**, are operated for 30 minutes per day with the backlight on*)

Battery power charge varies depending on the temperature and conditions of use.

* The brightness level of the backlight is at the default setting when the backlight is on.

.....

Audio function (for PEG-TJ35 only)

Audio frequency response

20 Hz to 20,000 Hz

Audio recording format

MP3 (96 k~256 kbps)

Sampling frequency

44.1 kHz

Output

Headphones: Stereo mini-jack

Maximum recording time

MP3 format

(when using a 128MB “Memory Stick” media, sold separately):

Approx. 65 minutes

(bit rate: 256 kbps)

Approx. 130 minutes

(bit rate: 128 kbps)

Approx. 170 minutes

(bit rate: 96 kbps)

Battery life

Playing audio files continuously:

Approx. 6.5 hours

(when playing audio files in HOLD mode)

Approx. 2 hours

(when playing audio files not in HOLD mode and the backlight on*)

* The brightness level of the backlight is at the default setting when the backlight is on.

.....

System requirements

The following are the system specifications required to run **Palm™ Desktop for CLIE** and software supplied on the Installation CD-ROM:

- OS:
Microsoft Windows 98 Second Edition,
Windows Millennium Edition,
Windows 2000 Professional,
Windows XP Home Edition,
Windows XP Professional
- CPU: Pentium II 400MHz or faster (Pentium III 500MHz or faster is recommended)
- RAM: 96MB or more (128MB or more is recommended, 256MB or more is recommended for Windows XP)
- Hard disk drive space: 200MB or more (350MB or more is recommended)
- Display: High Color or better, 800 × 600 dots or more is recommended
- CD-ROM drive
- USB port
- Pointing device such as a mouse or touchpad

Design and specifications are subject to change without notice.

CLIE™ handheld components

This chapter explains each part of your CLIE handheld, the supplied accessories, and additional information.

Front panel

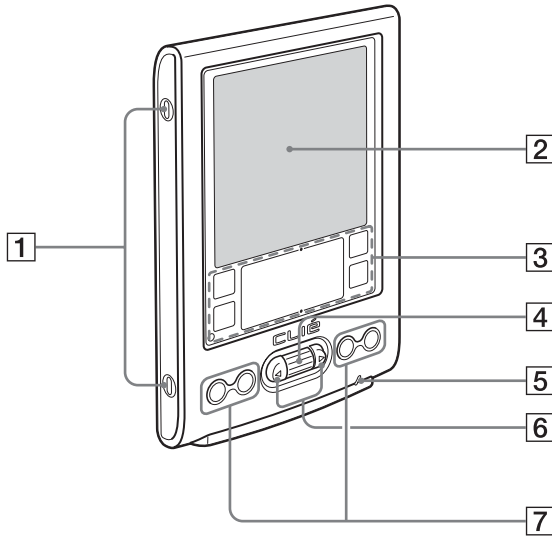

1 Cover slots

(Page 69)

For attaching the protective soft cover

2 Screen

(Page 65)

3 Silk Screen Area

4 Jog Dial™ navigator

(Page 22)

Use to select and run applications or items. Depending on the application, unique features are assigned.

5 POWER LED

(Page 8)

Lights or blinks when turned on. The LED shows the status of your CLIÉ handheld by its color.

Lights green: The power is on. (It also lights in HOLD mode)

Blinks green: Blinks a few moments when you operate any button on your CLIÉ handheld in HOLD mode.

Lights orange: The battery is being charged.

Blinks orange: Alarm function that notifies you at a preset time if you have set an alarm in an application, such as **Date Book**.

OFF: The power is off.

6 Left/Right Buttons

Moves the selection area of an item or an operation. Depending on the application, unique features such as displaying the previous or next screen are assigned.

7 Application Buttons

(Page 25)

Even when your CLIÉ handheld is turned off, pressing an application button turns on your CLIÉ handheld and starts that application.

Back panel

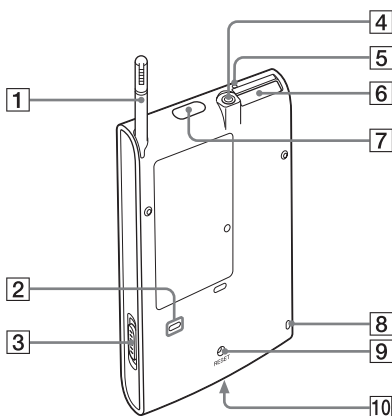

1 Stylus

(Page 10)

A pointed tool to operate your CLIÉ handheld by touching the screen with it.

**2 Speaker
(for PEG-TJ35 only)
Buzzer
(for PEG-TJ25 only)**

3 POWER/HOLD Switch

(Pages 9, 62)

Turns your CLIÉ handheld on and off, and sets your CLIÉ handheld to HOLD mode.

**4 Headphone Jack
(for PEG-TJ35 only)**

For headphones with a $\phi 3.5$ stereo mini jack (commercially available).

5 "Memory Stick" LED

(Page 63)

Blinks orange while your CLIÉ handheld is writing data to, or reading data from a "Memory Stick" media.

6 "Memory Stick" Slot

(Page 63)

Insert a "Memory Stick" media into this slot.

7 IR Port

(Page 64)

You can beam data between your CLIÉ handheld and another CLIÉ handheld or Palm OS[®] PDA.

8 Strap Hook

9 RESET Button

(Pages 32, 33)

Press to restart your CLIÉ handheld.

10 Interface Connector

(Page 8)

.....

POWER/HOLD switch

► Turning on/off your CLIÉ handheld

Slide down the POWER/HOLD switch

The POWER/HOLD switch will return to the center position after being released. Your CLIÉ handheld powers on, the last screen viewed is displayed, and the POWER LED lights green. To turn off your CLIÉ handheld, slide down the POWER/HOLD switch again and then release.

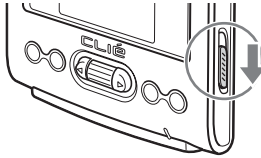

POWER/HOLD Switch

► Turning on/off the LCD backlight

Slide down the POWER/HOLD switch and hold it for more than two seconds.

► Turning on/off the HOLD mode

Slide up the POWER/HOLD switch

Putting your CLIÉ handheld in HOLD mode deactivates the touch screen. If you put the POWER/HOLD switch into the HOLD position while the power is on, the screen display turns off, even during an operation. To release the HOLD mode, slide down the POWER/HOLD switch to the center position.

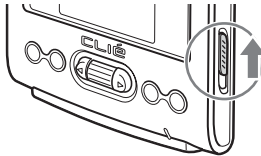

Using "Memory Stick" media

► Inserting "Memory Stick" media

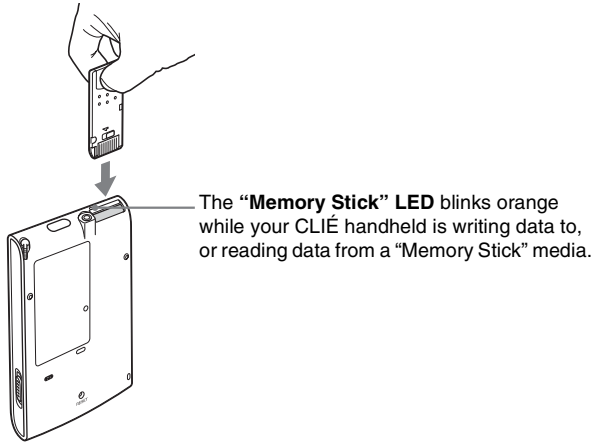

Note

Insert a "Memory Stick" media in the right direction. If you forcibly insert a "Memory Stick" media in the wrong direction, the "Memory Stick" slot may be damaged.

► Removing "Memory Stick" media

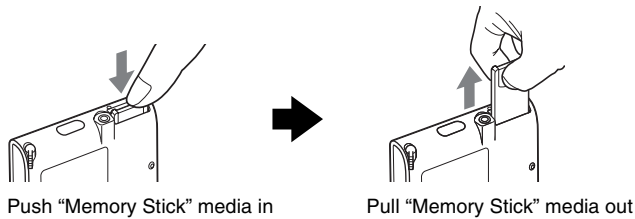

Note

Make sure that your CLIÉ handheld is not writing data/files to, or reading data/files from a "Memory Stick" media before removing it. (The "Memory Stick" LED blinks when it is reading or writing data/files.) If you remove a "Memory Stick" media while the "Memory Stick" LED is blinking, recorded data/files may be deleted or damaged.

.....

IR port

You can beam data or applications between your CLIÉ handheld and another CLIÉ handheld or Palm OS® PDA.

➔ For details, refer to “Beaming” in “Handbook” (PDF format).

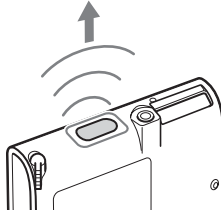

* Move your CLIÉ handheld gradually to find the most sensitive direction.

Locating the components of the CLIE Launcher

Tip

If a different screen is displayed, tap  (Home).

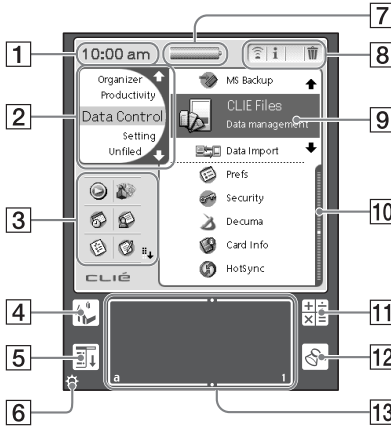

1 Time Indicator

Displays the current time. To change the display format, specify [Time:] from [Formats] in the **Preferences** screen.

- For details, refer to “Customizing your CLIÉ™ handheld (Preferences): Setting the display format for time, date, and numbers” in “Handbook” (PDF format).

2 CLIE Launcher groups list

The list of CLIE Launcher groups is displayed.

3 Favorite Applications (shortcuts)

You can create shortcuts to favorite applications.

4 Home icon

Tap to display the CLIE Launcher or Palm OS® Standard screen.

5 Menu icon

Tap to display menu of the current application.

6 Brightness Adjustment icon

Tap to display the dialog box for adjusting brightness. Four brightness levels are available.

7 Battery Remain icon

Displays the remaining battery power of your CLIÉ handheld. When you tap the icon, it displays the remaining battery power of your CLIÉ handheld as a percentage, and free memory space in your CLIÉ handheld or a “Memory Stick” media. When your CLIÉ handheld is being charged,  is displayed.

8 Application Manager icons

You can manage your applications with the application manager icons. The following are featured as standard functions.



: Beam



: Info



: Delete

➔ For details, refer to “CLIE™ handheld basic operations: Using CLIE Launcher: Application manager icons” in “Handbook” (PDF format).

Tip

Functions of application manager icons may be added when you install certain applications.

9 Application icon

10 Position indicator

11 Calculator

Tap to display the on-screen **Calculator**.

12 Find icon

Tap to display the dialog box finding data or applications.

13 Graffiti 2 writing area

Write strokes of **Graffiti 2** here.

Decuma Input can be launched from this area.

➔ For details, refer to “Entering text on your CLIE™ handheld: Using Decuma Input to enter text” in “Handbook” (PDF format).

.....

Status Information

You can display the **Status Info** dialog box by dragging the stylus from the Graffiti 2 writing area toward the upper left of the screen.

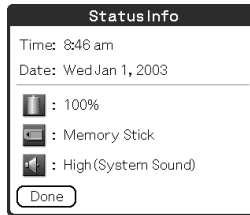
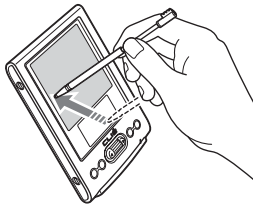

The status information displays the following icons. Additional icons will be displayed according to the applications in use. Tap each icon to get further information in detail.



Displays the battery's remaining charge.  is displayed while the battery is being charged.



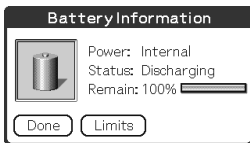

Tap to display the **Battery Information** dialog box.



Power: Power used
Status: Battery status
Remain: Remaining charge of the battery
(This is not displayed while being charged.)

Tap [Limits] to display the **Battery Limits** dialog box.

Each icon indicates the information on the “Memory Stick” media inserted into your CLIE handheld.

-  “Memory Stick” media is inserted.
-  “Memory Stick” media is not inserted.
-  “Memory Stick” media is write-protected.
-  “Memory Stick” media is not read correctly.
-  A “Memory Stick” compatible device is inserted.

Tap the icon to display the **Media Info** dialog box when “Memory Stick” media is inserted.

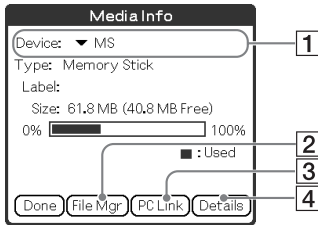

- 1** Media type
You can choose another device by tapping ▼ next to [Device:].
- 2** Tap to display **CLIE Files**.
- 3** Tap to display **Data Import**.
- 4** Tap to display the **Device Detail** dialog box for information on the device or driver.

From the **Media Info** dialog box, tap  (Menu) and then tap [Preferences...] from [Option] to select operations for “Memory Stick” media.

Tap to display the **Adjust Volume** dialog box.

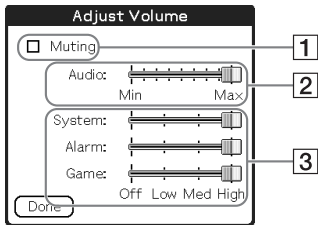

- 1** Turns off the sound of your CLIE handheld. When Muting mode is selected,  is displayed in the **Status Info** dialog box*.
- 2** Adjusts the volume level for playing back audio files*.
- 3** Adjusts the volume level for System sound, Alarm sound, and Game sound. This affects the [General] settings in **Preferences**.
➔ For details, refer to “Customizing your CLIE™ handheld (Preferences): Setting sounds” in “Handbook” (PDF format).

* Available for PEG-TJ35 only.

Tip

When a dialog box or screen such as the below is displayed

Tap the  icon to display tips and helpful advice.



Attaching the protective soft cover to your CLIÉ handheld

Place the tabs into the cover slots of your CLIÉ handheld (①), then slide the cover upwards until it locks into place (②).

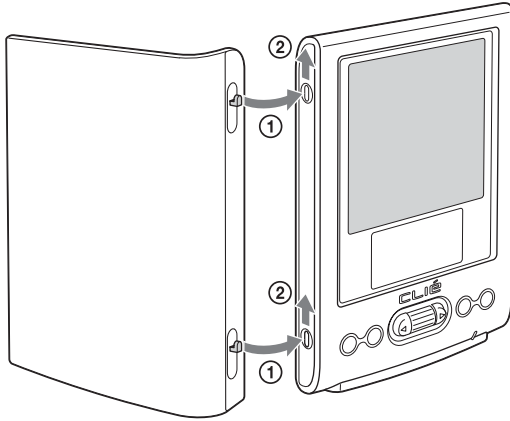

Removing the protective soft cover from your CLIÉ handheld

Slide the cover downwards (①), then remove it (②).

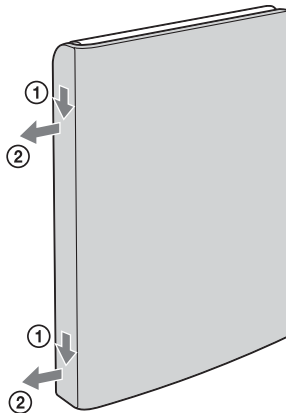

INDEX

A

- AC power adapter 6, 8
 - Applications
 - Installing 20
 - Quitting 23
 - Starting 22
-

B

- Backup 41
 - Basic Operations 21
 - Battery considerations 54
-

C

- CLIE Launcher 65
 - CLIE Manuals 35
 - Components 59
-

D

- Decuma Input 28
-

E

- Entering text 26
-

H

- HotSync® operation 29
-

I

- Initial setup 9
 - IR port 64
-

M

- "Memory Stick" LED 63
 - "Memory Stick" Slot 63
-

P

- Palm™ Desktop for CLIE 15
-

R

- Restarting
 - Hard reset 33
 - Soft reset 32
-

S

- Set date 12
 - Set time 11
 - Setting up 8
 - Specifications 57
 - Status Information 67
 - Stylus 10
-

T

- Tapping 10
 - Time zone 12
-

U

- USB cable 18
 - USB port 18
-

On the trademarks

Before using your CLIÉ handheld, make sure to read the accompanying End-User's License Agreement.

- Sony, CLIÉ, "Memory Stick", "Memory Stick Duo", "Memory Stick PRO", "MagicGate Memory Stick", Jog Dial, and their logos are trademarks of Sony Corporation.
- Palm, Palm Powered, the Palm logo, the Palm Powered logo, Palm OS, Graffiti, HotSync and the HotSync logo are trademarks of PalmSource, Inc.
- Graffiti 2 powered by Jot[®].
- Microsoft and Windows are registered trademarks of Microsoft Corporation.
- Pentium is a registered trademark of Intel Corporation.
- Intellisync is a trademark of Pumatech, Inc.
- Adobe and Acrobat are trademarks of Adobe Systems Incorporated.
- QuickTime and the QuickTime logo are trademarks of Apple Computer, Inc.
- Picsel and the Picsel logo are trademarks of Picsel Technologies, Ltd.
- Decuma is a trademark of Decuma AB in the United States and other countries.
- This product includes fonts owned by TypeBank Co., Ltd. under license.
- All other trademarks are trademarks of their respective owners.

For the latest information on support
and accessories,
check our official Sony CLIE website

For customers in the U.S.A. and Canada

<http://www.sony.com/clie/>

For customers in Australia, Hong Kong, Malaysia,
Mexico, New Zealand, Singapore, Taiwan,
Thailand, and U.A.E.

<http://www.sony.net/clie-online/>